

Power Plant Model Verification using MATLAB® and Simulink®

Graham Dudgeon, PhD
Principal Industry Manager – Utilities & Energy

Shripad Chandrachood
Senior Team leader – Application Engineering

Jonathan LeSage, PhD
Application Engineering

Hao Chen, PhD
Advanced Support Group

Workflow

PQF Replay

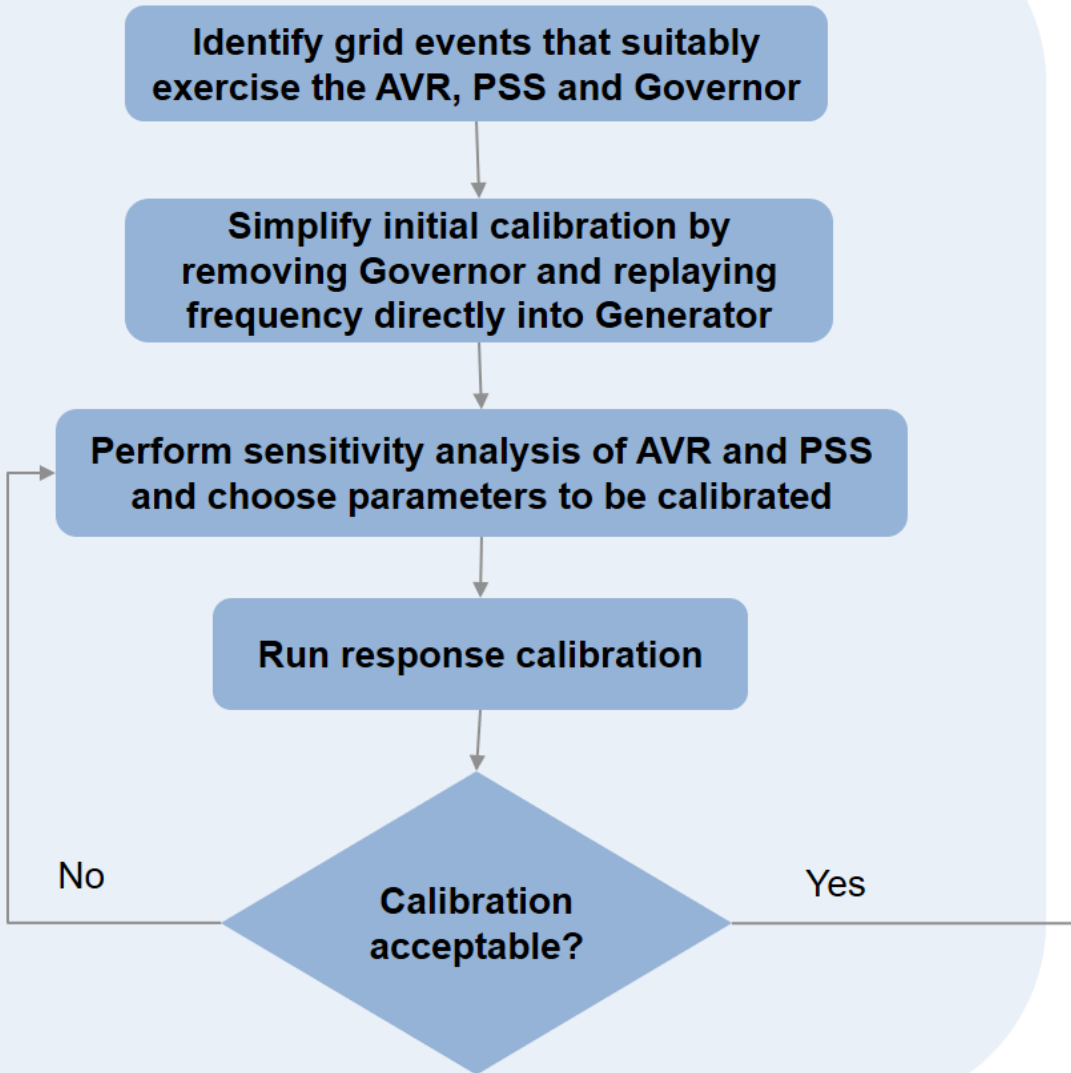

PQ Replay and/or VF Replay

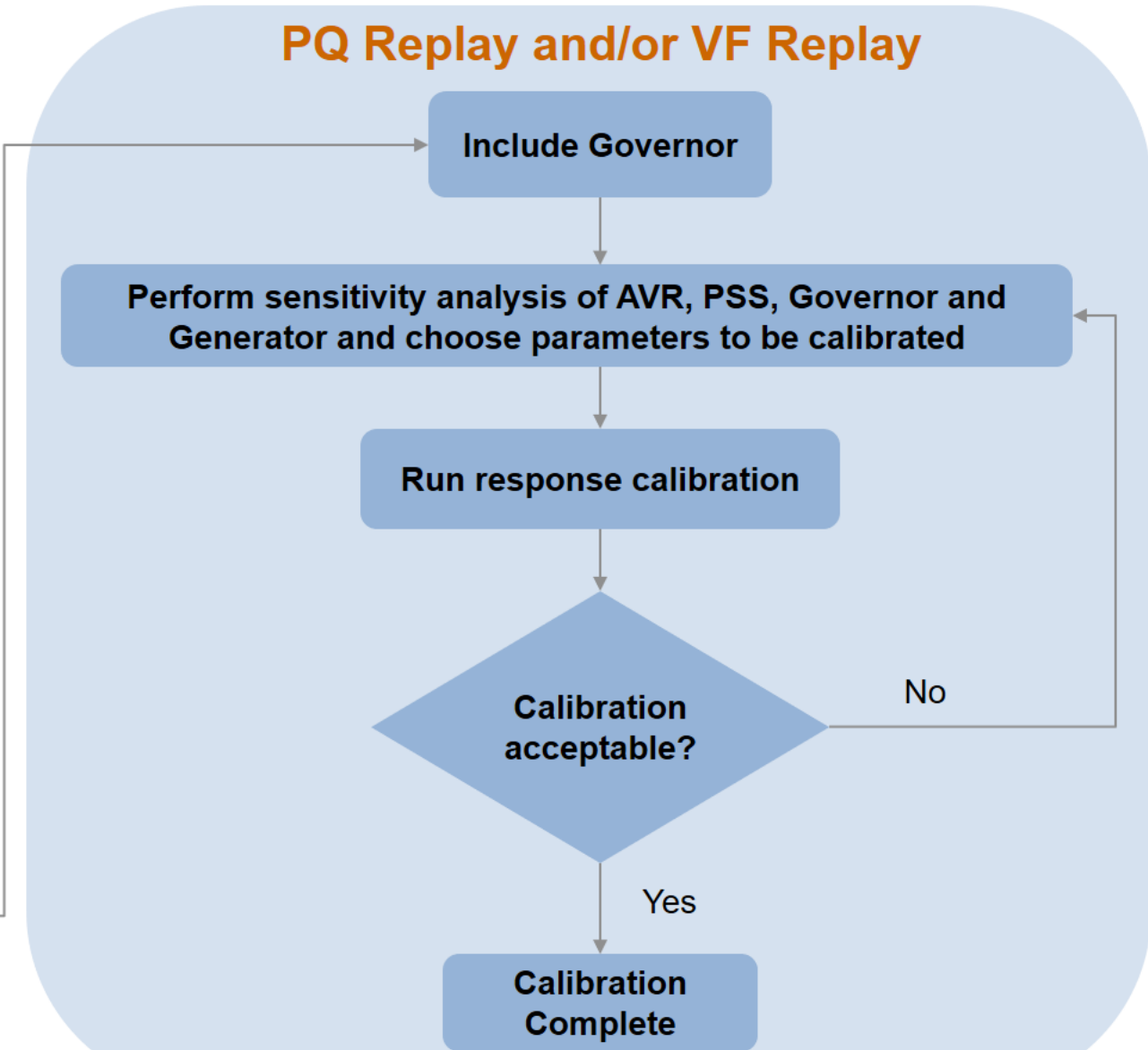

PQF Replay – GOV removed

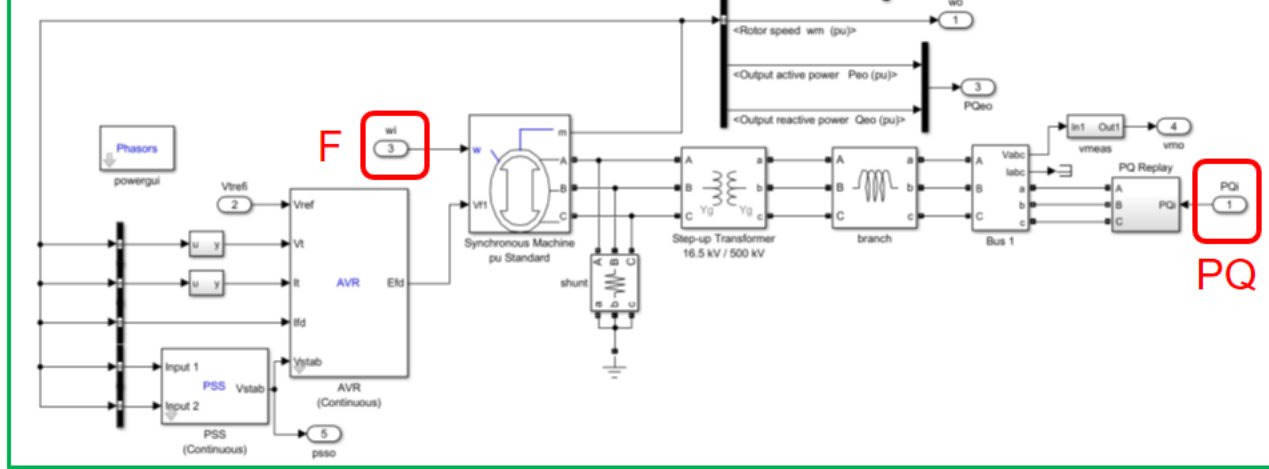

Parameter Sensitivity

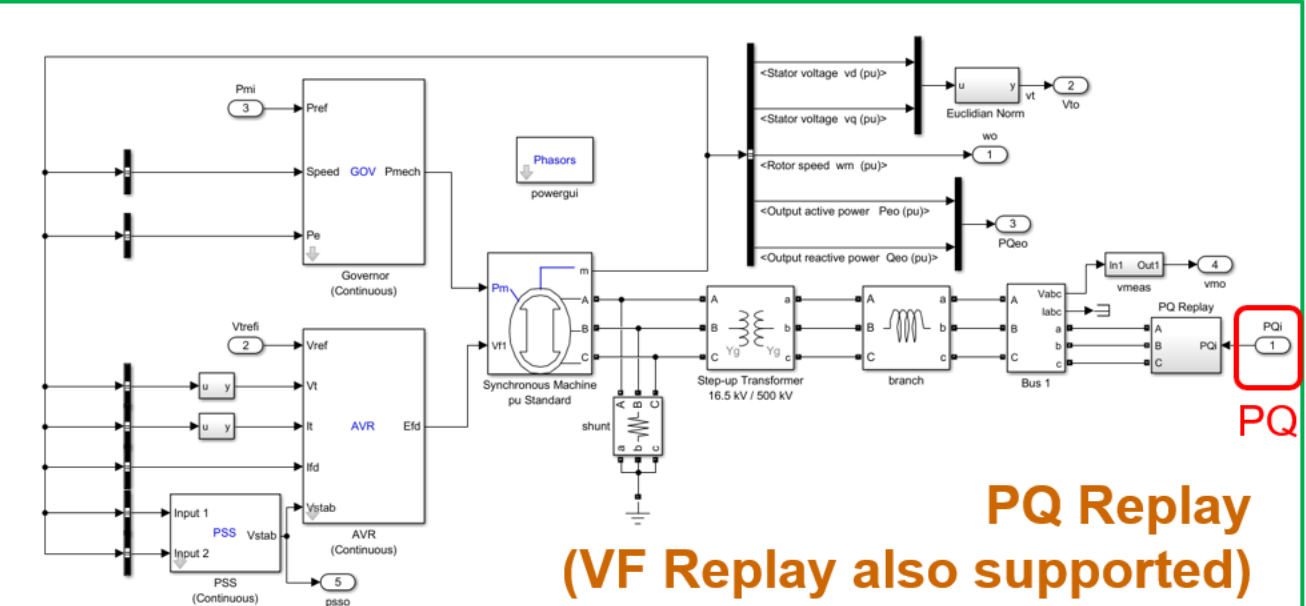
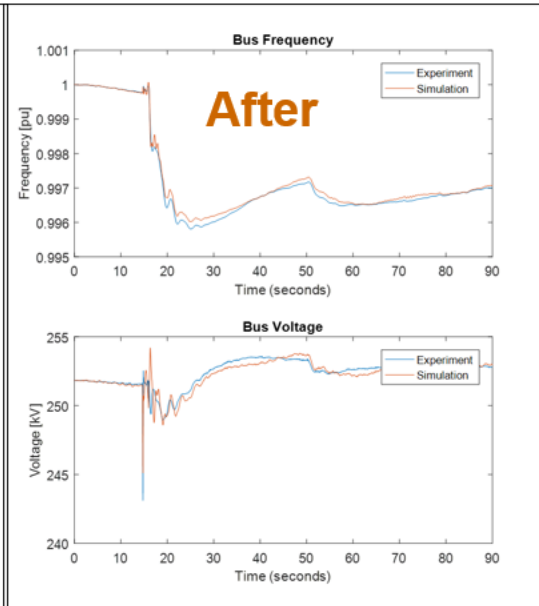
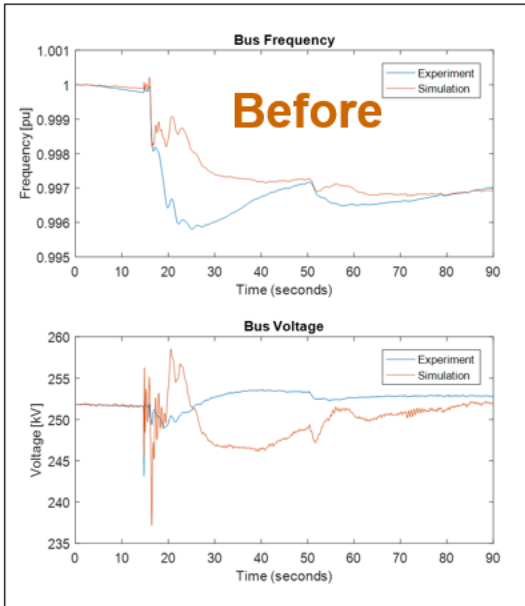
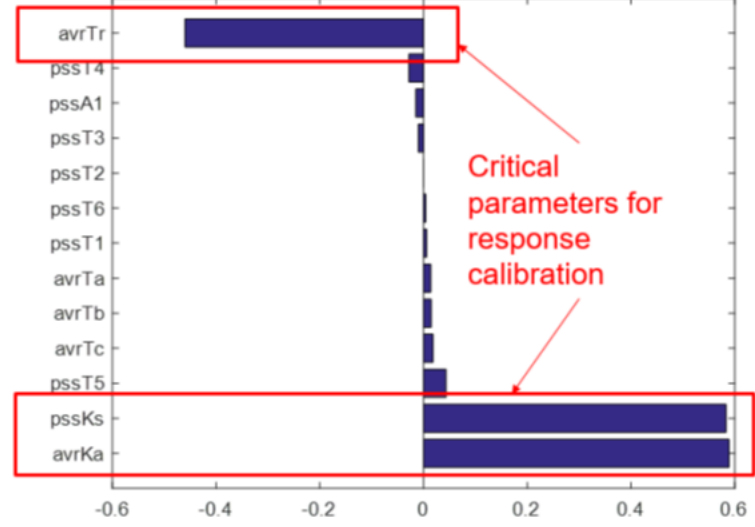

PQ Replay (VF Replay also supported)

Thank you!

For more information, follow this [link](#).